

INTELLIGENT ADDRESSABLE MODULES MIX-500 SERIES

Mircom's intelligent module products are designed to meet a wide range of applications. The monitor and control modules can be used to supervise and activate sounders, strobes, door closers, pull

stations, waterflow switches, conventional smoke detectors and more. The modules are addressed with easy-to-use rotary code switches and mount in a standard 4" x 4" x 2 1/8" junction box.



Intelligent Addressable Monitor Module (MIX-M500M)

The Intelligent Addressable Monitor Module (MIX-M500M) provides an address for a group of UL/ULC Listed normally open (N.O.) initiating devices, such as heat detectors, beam smoke detectors, 4-wire smoke detectors, waterflow switches, manual pull stations, etc. wired in a Class A (Style D) or Class B (Style B) initiating circuit. The MIX-M500M has an activated red LED.

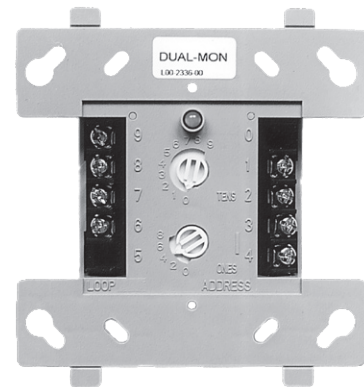

Intelligent Addressable Dual Monitor Module (MIX-M500DM)

The Intelligent Addressable Dual Monitor Module (MIX-M500DM) provides two independent 2-wire initiating device circuits at two separate, consecutive addresses. It is capable of monitoring two separate Class B (Style B) circuits simultaneously, making it ideal for water flow and tamper switch monitoring. The MIX-500DM has a single activated red LED that is common to either circuit.

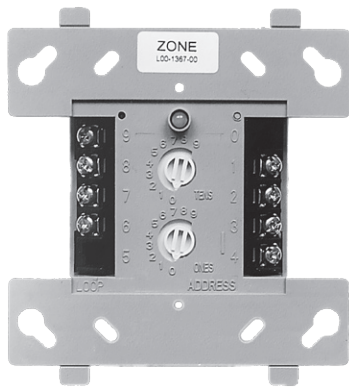

Intelligent Addressable Interface Module (MIX-M502M)

The MIX-M502M provides the same features as the MIX-M500M but also allows for the use of multiple, conventional 2-wire smoke detectors in the circuit. This module requires a resettable signal power source. The MIX-M502M internally supervises the separate power source. The red LED indicates when the module is activated. All two-wire detectors that are monitored must be UL/ULC compatible with the MIX-M502M module.



Intelligent Addressable Mini-Monitor Module (MIX-M501M)

The Intelligent Addressable Mini Monitor Module provides an address for a group of UL/ULC Listed Normally Open (N.O.) initiating devices, such as heat detectors, projected beam smoke detectors, 4-wire smoke detectors, waterflow switches, manual pull stations, etc. wired in a Class B (Style B) initiating circuit.



S5434



S5434



7300-1477-113
(MIX-M501M, MIX-500R,
MIX-500S & MIX-M502M)
7300-1477-126
(MIX-M500DM)
7300-1477-127
(MIX-M500M)



427-91-E
(MIX-M500, MIX-M501M)
87-01-E
(MIX-M500R, MIX-M500S)
227-03-E
(MIX-M500DM)



3017996

CATALOG NUMBER **5903**

NOT TO BE USED FOR INSTALLATION PURPOSES.



Intelligent Addressable Supervised Control Module (MIX-M500S)

The MIX-M500S Control module provides supervised monitoring of wiring to signal devices that require an external power supply to operate, such as horns, strobes, bells or speaker isolators. Conventional signals will require a 24 VDC power source and speakers will require an audio input. The MIX-M500S does not supervise the power source. A UL/ULC EOL relay such as the A77-716B(A) is required. The red LED will illuminate when the module is activated. The module is capable of Class A (Style Z) or Class B (Style Y) supervision.

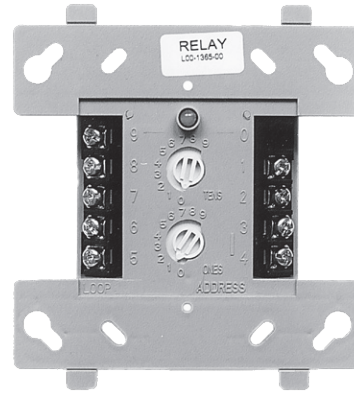

Intelligent Addressable Relay Module (MIX-M500R)

The Intelligent Addressable Relay Module connects to the same loop as the initiating devices and provides two isolated sets of Form-C contacts. The module allows the FX-2000 fire alarm control panel to switch these contacts on command. The MIX-M500R has an activated red LED which follows the state of the relay contacts.

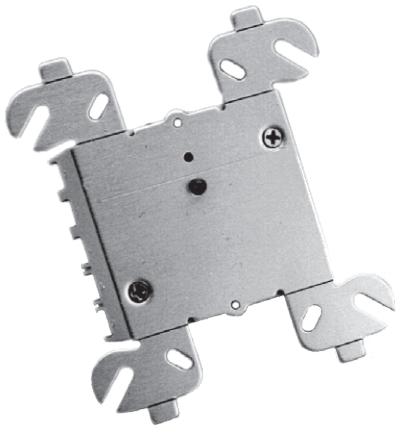

Fault Isolator Module (M500X)

The M500X Fault Isolator Module is used to protect the system against wire-to-wire short circuits on the analog loop. The modules should be spaced between groups of sensors or modules in a loop to protect the rest of the loop. In the event of a short circuit between any two fault isolator modules, both modules immediately switch to an open circuit condition and isolate any group of sensors between them. The remaining units on the circuit will continue to operate in a normal fashion (must be wired in Class 'A' or Style 6). A maximum load of 25 devices can be connected to an isolator to insure that the isolator powers up correctly.

Typical Wiring Diagrams

MIX-M500M Typical 2-wire initiating circuit configuration, Class B (NFPA Style B)

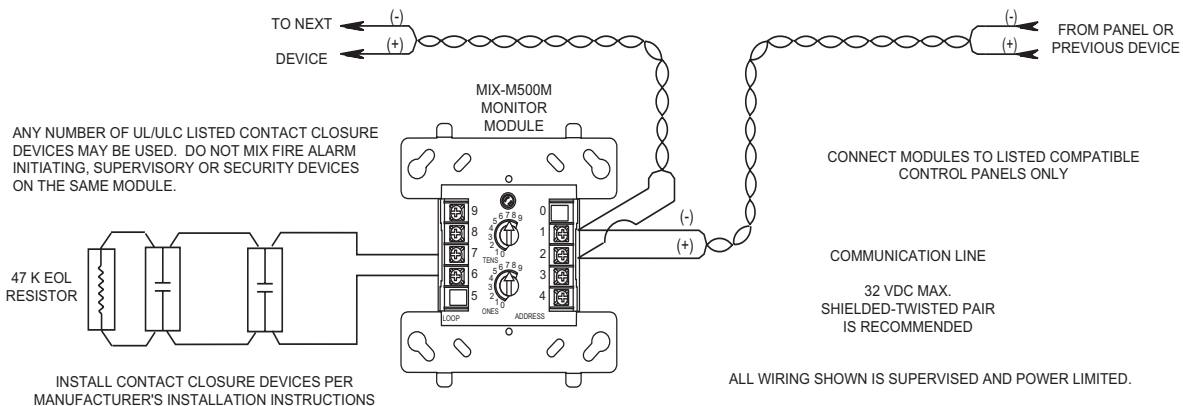

MIX-M502M Interface two-wire conventional detectors, Class B (NFPA Style B)

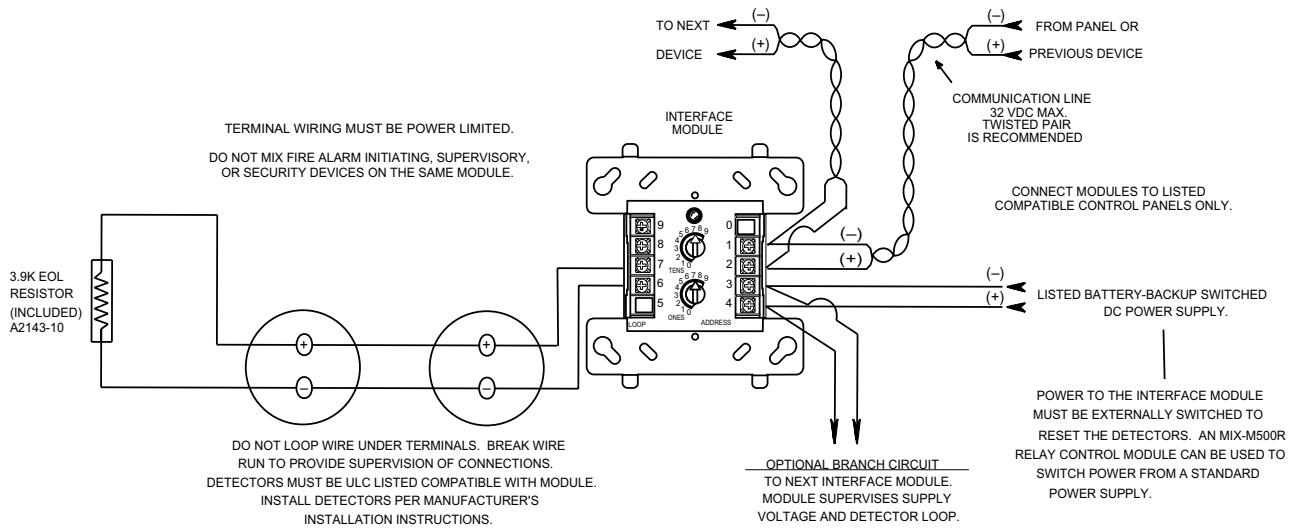

MIX-M500DM Typical 2-wire initiating circuit configuration, Class B (NFPA Style B)

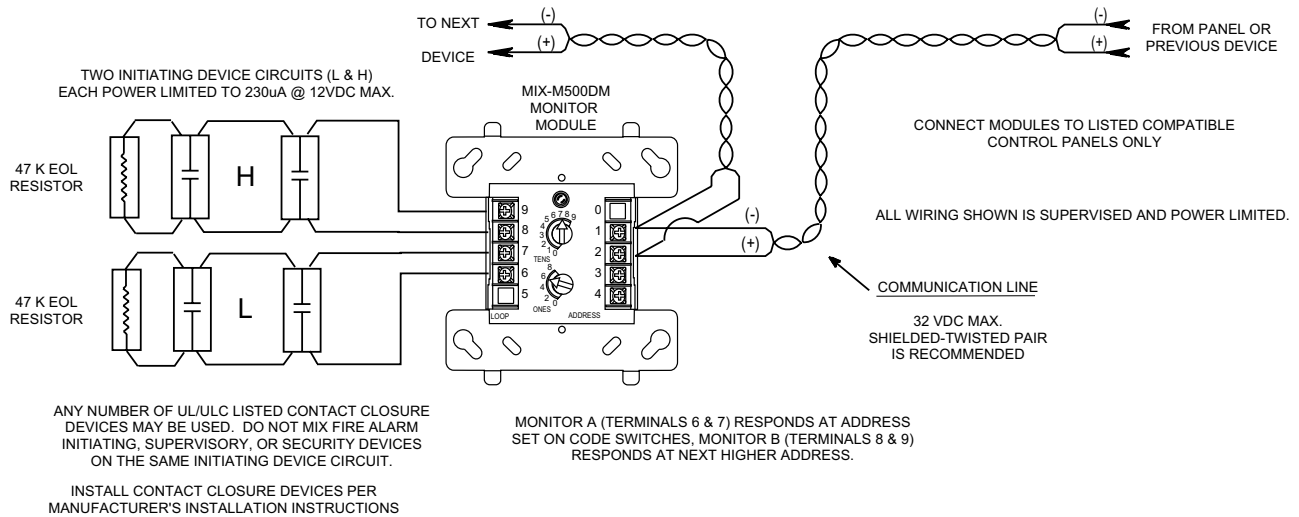

MIX-M500S Typical indicating circuit configuration, Class B (NFPA Style Y)

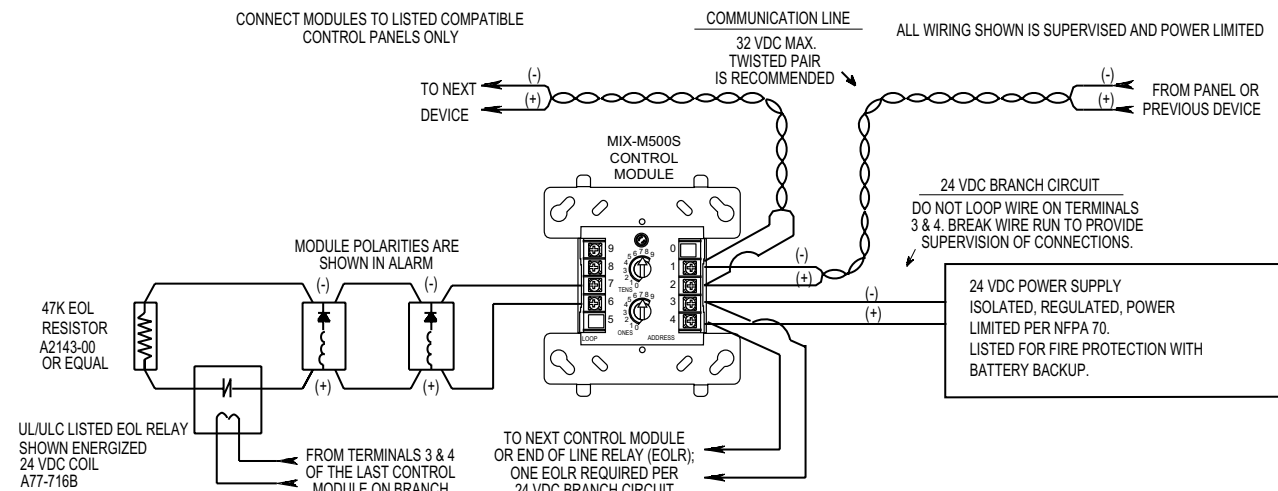

MIX-M500R Typical Relay Module Configuration

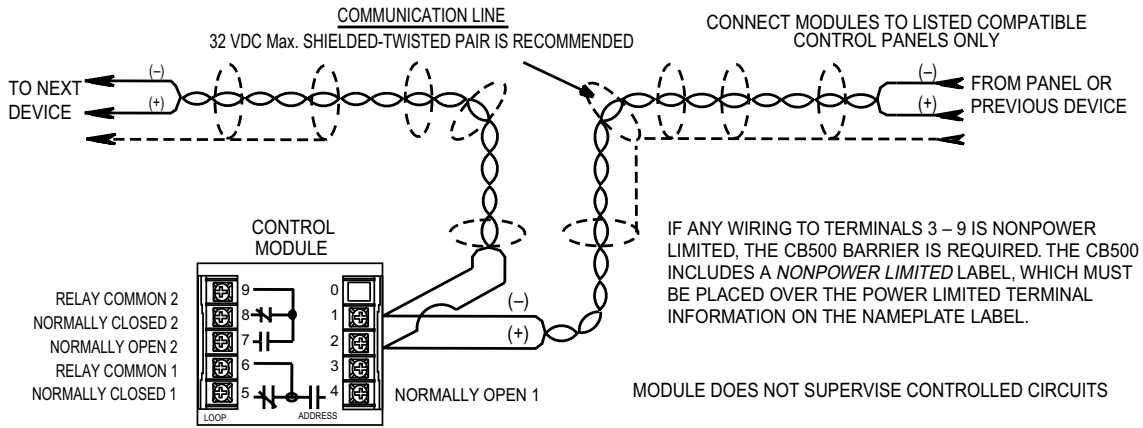

General Specifications

Operating Voltage

15-32 VDC

Communication Line Loop Impedance

40 .max.

Temperature Range

32° to 120°F (0° to 49°C)

Relative Humidity

10% to 93%: noncondensing

Dimensions

MIX-M501M: 1.7"H x 2.7"W x 0.5"D

Others: 4.65"H x 4.25"W x 1.1"D

Shipping Weight

M501M: 1.2 oz (37g)

Others: 6.3 oz (196g)

MIX-M500M, MIX-M500S, MIX-M501M Specifications:

Standby Current

400 µA max @ 24 VDC (one communication every 5 sec. with 47k EOL)

550 µA max @ 24 VDC (one communication every 5 sec. with EOL<1k)

5.5 mA (with LED latched on)

End-of-Line Resistance

47 k (included)

MIX-M502M Specifications:

Standby Current

300 µA max @ 24 VDC (one communication every 5 sec. with LED enabled)

External Power Supply

18-28 VDC (100 mV ripple max.)

End-of-Line Resistance

3.9 k (included)

External Supply Standby Current

11.5 mA @ 24 VDC (nominal)

External Supply Alarm Current

80 mA @ 24 VDC (nominal)

MIX-M500DM Specifications:

Standby Current

750 µA max. @ 24 VDC (one communication every 5 sec. with 47k EOL)

Alarm Current

970 µA max. (one communication every 5 sec.)

6 mA (with LED latched on)

End-of-Line Resistance

47 k (two included)

MIX-M500R Specifications:

Standby Current

300 µA @ 24 VDC (one communication every 5 sec. with LED enabled)

LED Current

5.5 mA (with LED latched on)

Relay Contact Ratings

3.0 A @ 30 VDC resistive

0.9 A @ 110 VDC resistive

0.9 A @ 125 VAC resistive

0.5 A @ 125 VAC inductive (PF=.35)

0.7 A @ 75 VAC inductive (PF=.35)

M500X Specifications:

Standby Current

450 µA max

Isolation Current

5 mA max

Fault Detection Delay

250 ms min.

Fault Detection Threshold

4 Volts

Line Restoration Threshold

7 Volts

Note: Mounting modules outside of the specified temperature range may cause module failure and erratic panel operation.

Ordering Information

MIX-M500M	Intelligent Addressable Monitor Module
MIX-M501M	Intelligent Addressable Mini-Monitor Module
MIX-M502M	Intelligent Addressable Interface Module
MIX-500DM	Intelligent Dual Monitor Module
MIX-M500S	Intelligent Addressable Supervised Control Module
MIX-M500R	Intelligent Addressable Relay Module
M500X	Fault Isolator Module

Note: For Canadian models add suffix "A".

NOT TO BE USED FOR INSTALLATION PURPOSES.



Canada

25 Interchange Way
Vaughan, Ontario L4K 5W3
Telephone: (905) 660-4655
Fax: (905) 660-4113

U.S.A.

4575 Witmer Industrial Estates
Niagara Falls, NY 14305
Toll Free: (888) 660-4655
Fax Toll Free: (888) 660-4113

Web page: <http://www.mircom.com> Email: mail@mircom.com

Distributed by:

ISO 9001:2000
REGISTERED



CAT. 5903
Rev. 4